

**Tower Crane / Grue à tour / Gru a torre
Grúa torre / Guindaste de torre**

Turmdrehkran 71 EC

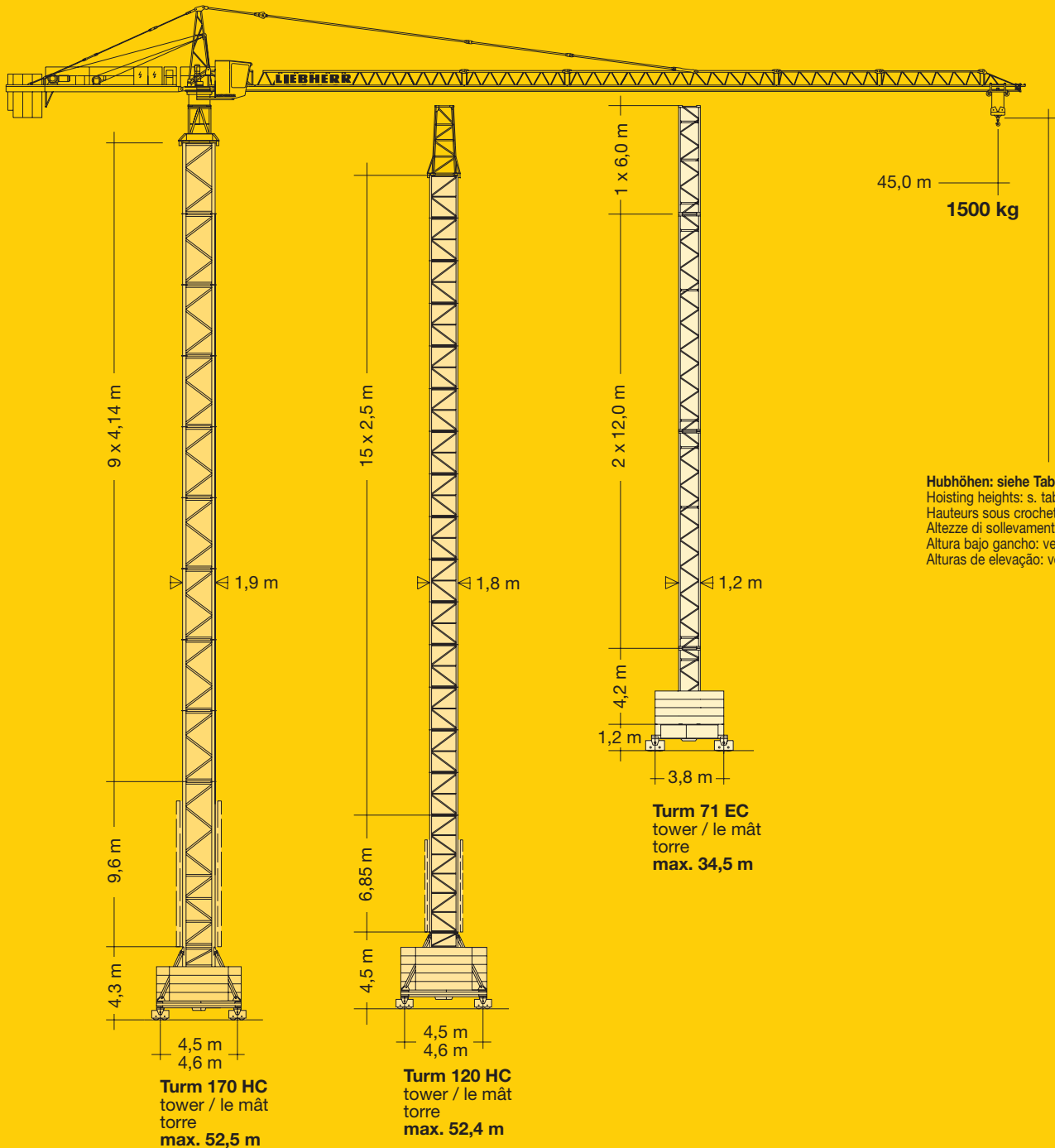

DIN

1 : 370

CD-1

LIEBHERR

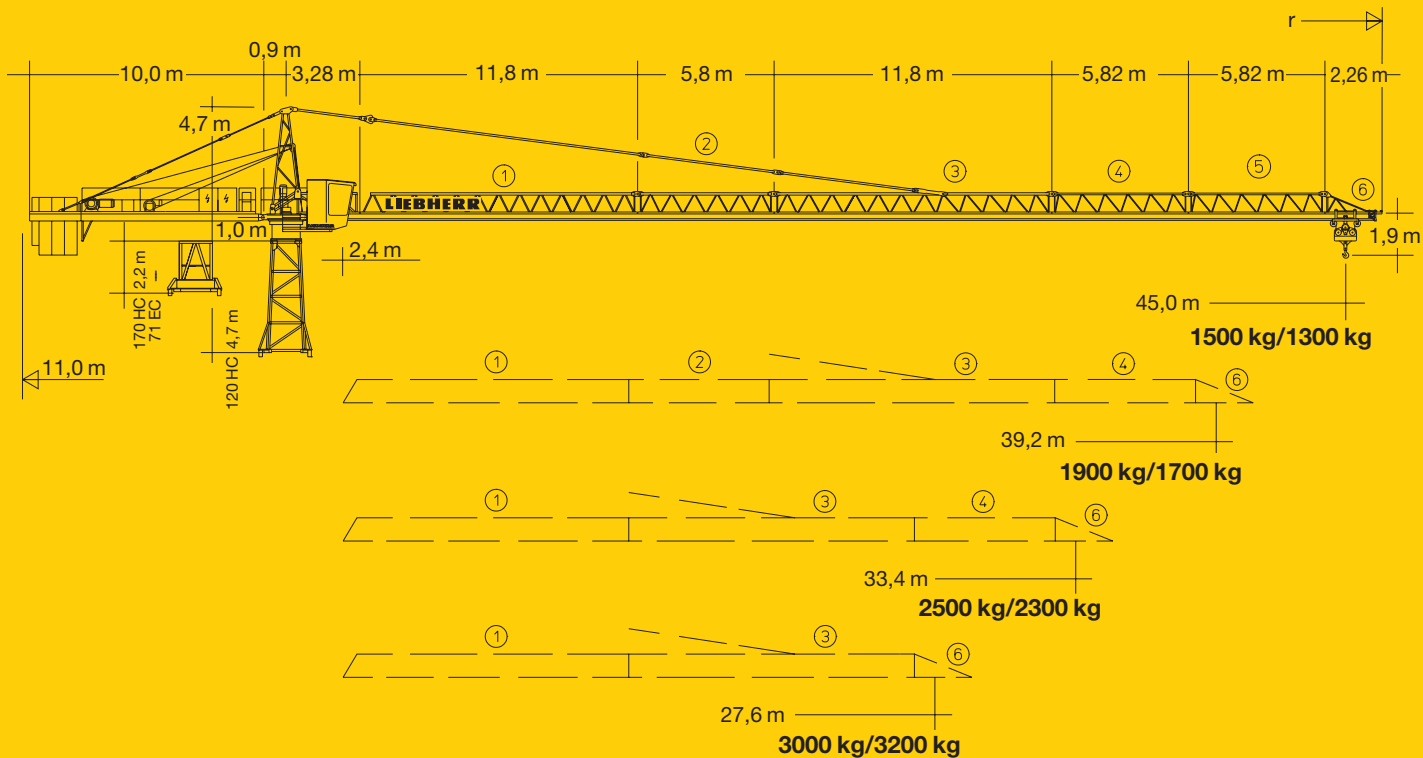

Hubhöhe

Hoisting height / Hauteur sous crochet / Altezza di sollevamento / Altura bajo gancho / Altura de montagem

	170 HC		120 HC	
15	-	-	48,1*	52,4*
14	-	-	45,6	49,9
13	-	-	43,1	47,4
12	-	-	40,6	44,9
11	-	-	38,1	42,4
10	52,5*	-	35,6	39,9
9	48,4*	52,5*	33,1	37,4
8	44,2	48,4*	30,6	34,9
7	40,1	44,2	28,1	32,4
6	35,9	40,1	25,6	29,9
5	31,8	35,9	23,1	27,4
4	27,7	31,8	20,6	24,9
3	23,5	27,7	18,1	22,4
2	19,4	23,5	15,6	19,9
1	15,2	19,4	13,1	17,4
0	11,1	15,2	10,6	14,9
	m		m	

* Weitere Hubhöhen sowie Klettern im Gebäude auf Anfrage. / Further hoist heights and climbing in the building on request.
 Hauteurs sous crochet plus élevées et hissage dans le bâtiment sur demande. / Altre altezze di sollevamento come pure varianti di gru allungabili: su richiesta. / Para alturas bajo gancho superiores y trepado en el interior del edificio, consultar. / Outras alturas de elevação e subida no edifício: conforme ao pedido.

Ausladung und Tragfähigkeit

Radius and capacity / Portée et charge / Sbraccio e portata / Alcances y cargas / Alcance e capacidade de carga

m	r	m/kg	m/kg															
									25,0	27,6	29,0	33,4	35,0	37,0	39,2	41,0	43,0	45,0
45,0	(r = 46,7)	2,4 - 25,3 3000							3000	2700	2550	2150	2030	1900	1770	1680	1590	1500
39,2	(r = 40,9)	2,4 - 26,7 3000							3000	2890	2720	2300	2180	2040	1900			
33,4	(r = 35,1)	2,4 - 28,6 3000							3000	3000	2950	2500						
27,6	(r = 29,3)	2,4 - 27,6 3000							3000	3000								

m	r	m/kg	m/kg															
			15,0	17,0	19,0	21,0	23,0	25,0	27,6	29,0	33,4	35,0	37,0	39,2	41,0	43,0	45,0	
45,0	(r = 46,7)	2,4 - 25,3 2800	2,4 - 14,7 5600	5460	4640	4030	3550	3160	2840	2500	2350	1950	1830	1700	1570	1480	1390	1300
39,2	(r = 40,9)	2,4 - 26,7 2800	2,4 - 15,5 5600	5600	4960	4310	3800	3380	3050	2690	2520	2100	1980	1840	1700			
33,4	(r = 35,1)	2,4 - 28,6 2800	2,4 - 16,5 5600	5600	5390	4690	4130	3690	3320	2930	2750	2300						
27,6	(r = 29,3)	2,4 - 27,6 2800	2,4 - 17,6 5600	5600	5600	5090	4500	4020	3620	3200								

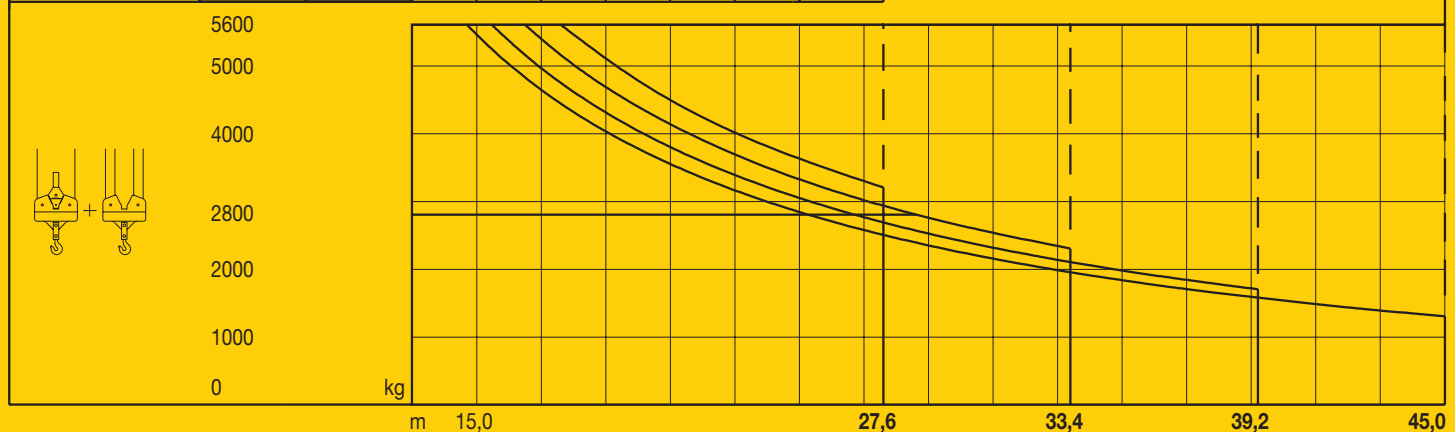





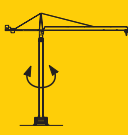

		71 EC				
6 m	12 m	2) 34,5	40,5	40,3	39,5	45,3
4,2 m	4,2 m	-	36,3	36,1	35,3	41,1
* + Grundturmstück		1) 24,3	30,3	30,1	29,3	35,1
6	3	18,3	24,3	24,1	23,3	29,1
5		12,3	18,3	18,1	17,3	23,1
4	2	6,3	12,3	12,1	11,3	17,1
3			6,3	6,1	5,3	11,1
2	1					
1						
Anzahl der Turmstücke Number of tower sections Nombre d'éléments de mât N. elementi di torre Cant. secciones de torre Núm. de peças de torre						

* Für die maximale Hakenhöhe ist das 4,2 m lange Grundturmstück erforderlich. / The 4,2 m long base tower section is necessary to achieve maximum hook height. / Pour obtenir la hauteur sous crochet maxi, il faut monter l'élément de mât de base d'une longueur de 4,2 m. Per ottenere l'altezza max. di gancho, si deve montare la sezione di torre basi di lunghezza 4,2 m. / Para la altura máxima bajo gancho se necesita el tramo base de 4,2 m. / Para alcançar a altura max. do gancho, é necessário utilizar a peça de base de torre de comprimento 4,2 m.

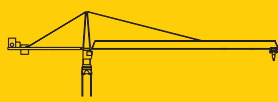
Geschwindigkeiten

Speeds / Vitesse / Velocità / Velocidades / Velocidades













	U/min 0,85 sl./min tr./min	6,3 kW
	8,0 / 29,1 / 54,0 m/min	3,0 kW
	25,0 m/min	2 x 2,2 kW (71 EC) 2 x 3,0 kW (120 HC) 2 x 7,5 kW (170 HC)
	kVA	 22 kW 22 kW, FU 40,0 30,0

	Stufe / Step / Cran Marcia / Grado Velocidade	kg	m/min
 22,0 / 18,0 / 4,0 kW, KL WIW 220 KY 006 62,0 m LS- Trommel 4 Lagen Layers Couches strati camadas capas	1	3000	2800
	2	3000	2800
	3	1700	1700
	1	5600	3,6
	2	5600	17,6
	3	3400	35,0
 22,0 kW, FU WIW 230 KY 002 78,0 m LS- Trommel 5 Lagen Layers Couches strati camadas capas	1	3000	2900
	2	3000	2900
	3	2400	2200
	4	1400	1500
	1	5600	1,9
	2	5600	19,0
	3	4700	23,0
	4	3100	35,0

Kolli-Liste

Packing List / Liste de colisage / Lista dei colli
Lista de contenido / Lista de embalagem

Montagegewichte: siehe Betriebsanweisung.
Erection weights: see instruction manual.
Poids de montage: voir manuel de service.
Pesi di montaggio: vedasi le istruzioni sull'uso.
Pesos de montagem: vejam-se as instruções p. uso.
Peso para el montaje: según manual.

Kranoberteil		Upper part of crane / Partie supérieure de gru Parte superiore della gru / Parte superior grúa Parte superior do guindaste	L (m)	B (m)	H (m)	kg		
Pos. Item Rep. Voce Pos. Ref.	Anz. Qty. Qte. Qta. Cant.	Komplettkrankopf / One-piece machine deck / Tête de grue Testa completa della gru Módulo giratorio / Cabeça compl. de guindaste		12,00	2,44	2,38	9000	
2	1	Übergangsstück / Adapter section Tronçon de conversation / Spezzone collegamento / Tramo de adaptación Peça ligadora	 	120 HC 170 HC	5,00 2,41	2,20 2,50	2,30 2,30	2540 2750
3	1	Kabine mit Podest / Cabin with platform Cabine avec plate-forme Cabina con piattaforma / Cabina con plataforma / Cabina con plataforma	 	3,10	1,30	2,20	610	
4	1	Drehbühne kpl. / Slewing platform cpl. Partie tournante cpl. / Piattaforma girevole compl. / Conjunto plataforma de giro / Plataforma giratória compl.	 	4,20	1,80	1,97	3280	
5	1	Turmspitze / Tower head section Porte-flèche / Testa porta-braccio Cabeça de apiao de lança / Cabeza de torre	 	4,55	1,00	1,35	575	
6	1	Gegenausleger kpl. / Counter-jib cpl. Contre-flèche cpl. / Controbraccio, compl. / Contrapluma compl. Contra-lança, compl.	 	L1 10,20 L2 8,00	1,90	2,32	4070	
7	1	Ausleger-Anlenkstück / Jib heel section / Pied de flèche / Settore articolato di braccio / Base articulada de lança / Pluma tramo primero	 	12,00	0,97	0,96	Ⓢ 1300	



Technische Daten







Technical data - Caractéristiques techniques

Caratteristiche tecniche - Características técnicas - Datos técnicos







Pos.
Item
Rep
Voce
Pos.
Ref

Anz.
Qty.
Qte.
Qta.
Cant.
Cant.





Einzelgewichte / Single
weights / Poids individuels.
Pesi di componenti.
Pesos de peças componentes.
Pesos unitarios.

				L (m)	B (m)	H (m)	kg	
8	1	Ausleger-Zwischenstück / Intermediate jib section / Elément interm. de flèche Spezzone di braccio / Peça suplementar da lança / Tramo intermedio pluma			6,00	0,97	0,96	② 685
					12,00	0,97	0,96	③ 1200
					6,02	0,97	0,96	④ 342
					6,02	0,97	0,96	⑤ 280
9	1	Ausleger-Kopfstück / Jib head Pointe de flèche / Punta freccia Cabeça de lança / Tramo punta de pluma			2,31	0,97	0,93	⑥ 125
10	1	Lasthaken / Load hook Crochet de levage / Gancio di carico Polipasto / Gancho de suspensão			1,30	0,93	0,26	340





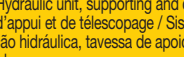









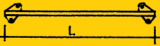



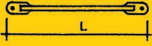

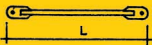
Turm Tower / Mât / Torre Torre / Torre

11	1	Turmstück / Tower section Element de mât / Elemento di torre Torre / Torre			71 EC	3,00	1,20	1,20	1080
					120 HC	6,00	1,20	1,20	1480
					120 HC	2,50	1,80	1,80	1090
					120 HC	5,00	1,80	1,80	1830
					170 HC	4,14	1,90	1,90	1850
12	1	Turmstück lang / Long tower section Elément de mât long / Elemento di torre lungo / Tramo de torre largo / Peça de torre, comprida			71 EC	12,00	1,20	1,20	2610
					120 HC	10,00	1,80	1,80	3425
13	1	Grundturmstück / Base tower section Mât de base / Elemento di torre base Tramo torre base / Peça de base de torre			71 EC	4,20	1,20	1,20	1340
					120 HC	6,85	1,80	1,80	2610
					120 HC	10,00	1,80	1,80	3530
					170 HC	9,60	1,90	1,90	4350

Klettereinrichtung Climbing equipment / Equipement de télescopage / Attrezzatura per allungamento della gru Equipo de trepado / Acesoários p. subida no edificio

14	1	Führungsstück kpl. / Guide section cpl. Cage télescopique cpl. / Gabbia di sopraelevazione compl. / Peça de guia compl. / Torre de montaje completa			120 HC	6,45	2,10	2,42	2660
					120 HC	9,60	2,10	2,42	4410
					170 HC	9,04	2,31	2,28	4750
15	1	Hydraulikanlage, Stütz- und Klettertraverse / Hydraulic unit, supporting and climbing cross members / Système hydraulique avec traverses d'appui et de télescopage / Sistema hidráulico, traversa di appoggio e allungamento gru / Instalação hidráulica, travessa de apoio e subida / Sistema hidráulico con travesa de apoyo y trepado			120 HC	2,87	2,12	1,06	1800
					170 HC	2,30	1,10	1,00	1100

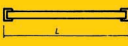
Unterwagen Undercarriage / Châssis / Carro della gru Carro con mástil / Carro de guindaste

16	2	Fahrschemel mit Antrieb / Rail bogie with drive / Bogie moteur / Telaio con gruppo propulsore / Quadro sem grupo de propulsão / Caja rodillo motriz			71 EC	0,75	0,55	0,55	307
					120 HC	1,38	0,88	0,87	900
					170 HC	1,46	0,84	0,87	920
17	2	Fahrschemel ohne Antrieb / Rail bogie without drive / Bogie fou / Telaio senza gruppo propulsore / Quadro com grupo de propulsão / Caja rodillo conducido			71 EC	0,65	0,30	0,55	222
					120 HC	1,17	0,60	0,87	860
					170 HC	1,15	0,60	0,87	880
18	1	Tragholm lang / Long support arm Longeron long / Longherone lungo Brazo largo soporte / Travessa comprida			120 HC	7,12	0,75	0,65	950
					170 HC	7,15	0,80	0,70	1070
19	2	Tragholm kurz / Short support arm Longeron court / Longherone corto Brazo corto soporte / Travessa curta			120 HC	3,45	0,56	0,55	408
					170 HC	3,45	0,60	0,70	500
20	4 2 + 2	Randträger / Border support Traverse / Supporti base Traviesa / Apoio de bordo			120 HC	4,02	0,35	0,12	95
					170 HC	4,08 - 4,30	0,16 - 0,33	0,11 - 0,14	80 - 200
21	4	Stützholm / Support strut Hauban de châssis / Correnti di appoggio Tirante vertical / Travessa de apoio			120 HC	3,78	0,15	0,22	200
					170 HC	3,53	0,25	0,17	240
22	1	Unterwagen-Turmstück / Undercarriage tower section / Mât de châssis / Elemento di torre del carro / Tramo de carro Peça de torre do chassis			120 HC	3,50	2,06	2,06	1320
					170 HC	3,30	2,15	2,15	2000
23	2	Fundamentkreuz mit Spindeln, Tragholm lang / Cruciform base with outrigger jacks, long support arm / Châssis en croix avec vérins, longeron long / Base incrociata con aste, longherone lungo / Tramo largo base cruciforme, con husillos Base cruciforme com árvores, travessa comprida			71 EC	3,8 m 5,80 3,0 m 4,70	0,60	0,80	1860
							0,60	0,80	1625
24	2	Fundamentkreuz fahrbar, Tragholm lang / Cruciform rail going, long support arm / Châssis en croix roulant, longeron long / Base incrociata mobile, longherone lungo / Brazo soporte largo de base cruciforme para traslación sobre vía Base cruciforme móvel, travessa comprida			71 EC	3,8 m 5,60 3,0 m 4,50	0,60	0,90	1750
							0,60	0,90	1510
25	4	Fundamentkreuz fahrbar, Randträger / Cruciform rail going, border support / Châssis en croix roulant, traverse Base incrociata mobile, traversa / Traviesa de base cruciforme / Base cruciforme móvel, apoio de bordo (Fahrwerke wie Pos. 16 und 17) / (Travel gears as under item 16 and 17) / (Mécanismes de translation comme pos. 16 et 17) / (Gruppi propulsori marcia come da voce 16 e 17) / (Mecanismos de traslación como Pos. 16 y 17) / (Grupos de propulsão de marcha: igual a ref. 16 et 17)			71 EC	3,8 m 3,40 3,0 m 2,60	0,20	0,35	114
							0,20	0,35	91
26	1	Kiste mit Kleinteilen / Crate with small parts Caisse contenant des accessoires / Cassa con accessori Caja con accesorios / Caixa de acessórios			120 HC 170 HC	2,00	1,00	1,00	2000

121 P – 3069 H1 B3 DIN 15018 • BGL 2112-0071 • 05.99 / 6

Konstruktionsänderungen vorbehalten! / Subject to alterations!
Sous réserves de modifications! / Si fa riserva di modifiche!
Salvo modificação da construção! / ¡Sujeto a modificaciones!

Printed in Germany.



LIEBHERR-WERK BIBERACH GMBH, Postfach 1663, D-88396 Biberach an der Riß
☎ (0 73 51) 41-0, Fax (0 73 51) 4 12 25, www.lbc.liebherr.de, E-Mail: info@lbc.liebherr.com