

Turmdrehkran

50 EC-B 5

Tower Crane / Grue à tour / Gru a torre / Grúa torre
Guindaste de torre / Башенный поворотный кран

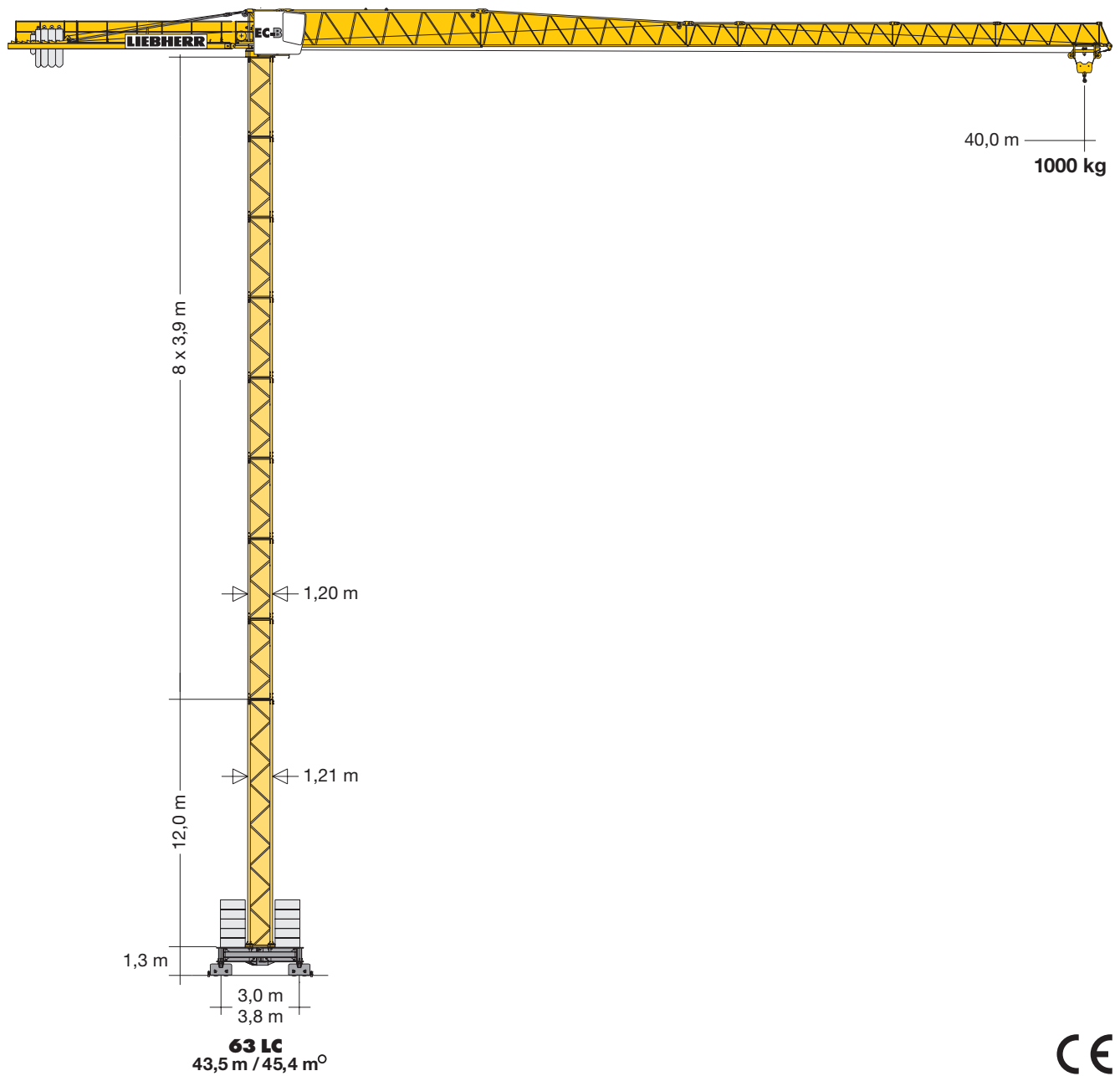

CE
EN 14439:2009-C25

LIEBHERR

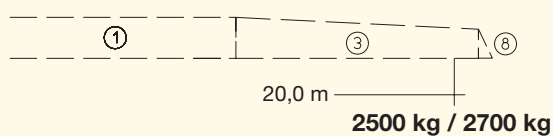
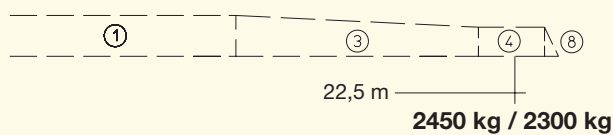
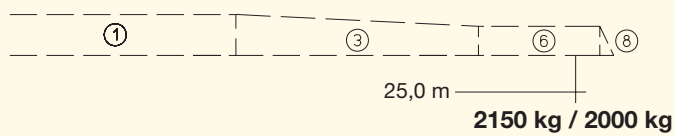
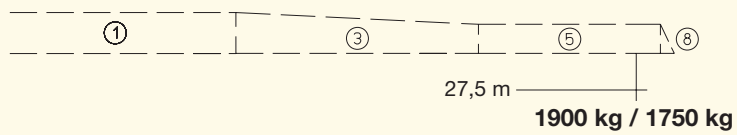
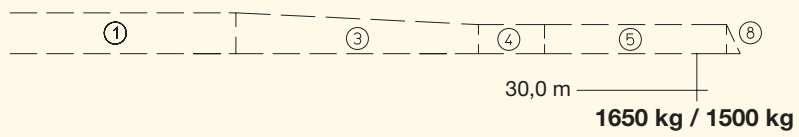
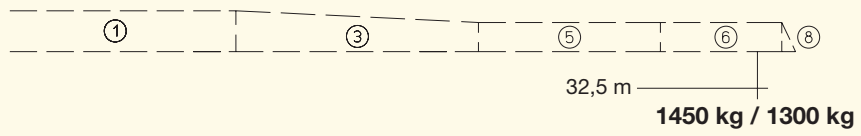
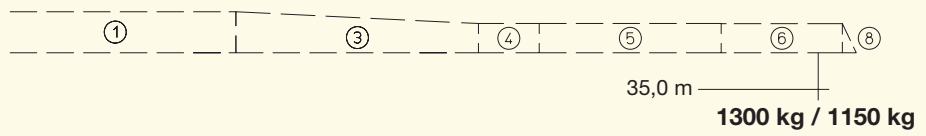
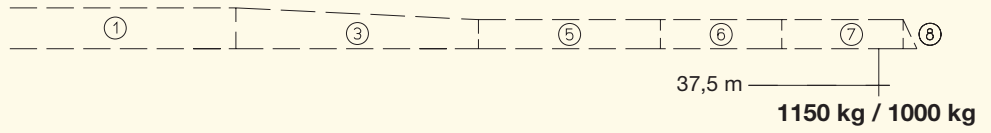
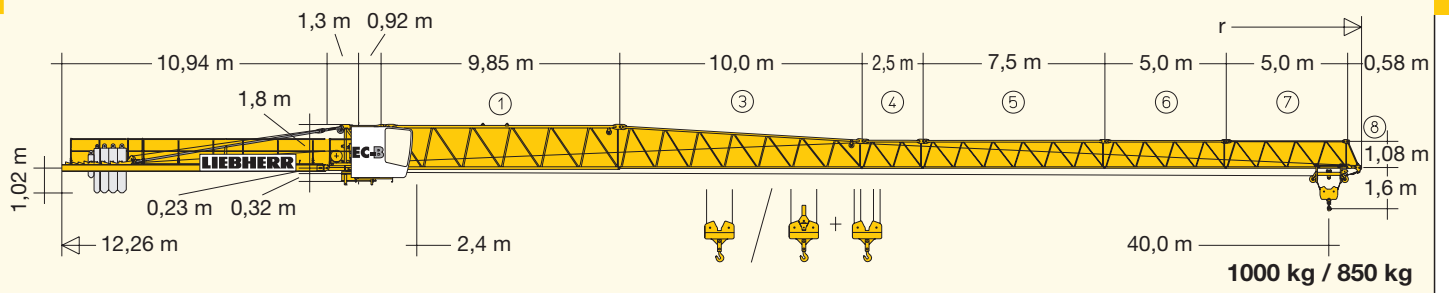

Ausladung und Tragfähigkeit

Radius and capacity / Portée et charge / Sbraccio e portata
Alcances y cargas / Alcance e capacidade de carga / Вылет и грузоподъемность

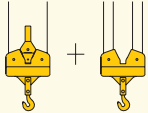
				m/kg													
				10,0	12,5	15,0	17,5	20,0	22,5	25,0	27,5	30,0	32,5	35,0	37,5	40,0	
m	r	m/kg															
40,0	(r = 41,5)	2,4-19,0	2500	2500	2500	2500	2500	2350	2050	1810	1620	1450	1310	1190	1090	1000	
37,5	(r = 39,0)	2,4-19,8	2500	2500	2500	2500	2500	2470	2150	1900	1700	1530	1380	1260	1150		
35,0	(r = 36,5)	2,4-20,3	2500	2500	2500	2500	2500	2500	2220	1960	1750	1580	1430	1300			
32,5	(r = 34,0)	2,4-20,6	2500	2500	2500	2500	2500	2500	2250	1990	1780	1600	1450				
30,0	(r = 31,5)	2,4-21,1	2500	2500	2500	2500	2500	2500	2320	2050	1830	1650					
27,5	(r = 29,0)	2,4-21,7	2500	2500	2500	2500	2500	2500	2400	2130	1900						
25,0	(r = 26,5)	2,4-21,9	2500	2500	2500	2500	2500	2500	2430	2150							
22,5	(r = 24,0)	2,4-22,1	2500	2500	2500	2500	2500	2500	2450								
20,0	(r = 21,5)	2,4-20,0	2500	2500	2500	2500	2500										
				m/kg													
				10,0	12,5	15,0	17,5	20,0	22,5	25,0	27,5	30,0	32,5	35,0	37,5	40,0	
m	r	m/kg															
40,0	(r = 41,5)	2,4-18,4	2500	2,4-10,3	5000	3990	3210	2660	2250	1940	1690	1480	1310	1170	1050	940	850
37,5	(r = 39,0)	2,4-19,1	2500	2,4-10,7	5000	4160	3360	2790	2360	2040	1770	1560	1390	1240	1110	1000	
35,0	(r = 36,5)	2,4-19,6	2500	2,4-10,9	5000	4280	3450	2870	2430	2100	1830	1610	1430	1280	1150		
32,5	(r = 34,0)	2,4-19,8	2500	2,4-11,0	5000	4330	3490	2900	2470	2130	1860	1640	1450	1300			
30,0	(r = 31,5)	2,4-20,2	2500	2,4-11,3	5000	4440	3590	2980	2540	2190	1910	1690	1500				
27,5	(r = 29,0)	2,4-20,8	2500	2,4-11,6	5000	4590	3710	3080	2620	2270	1980	1750					
25,0	(r = 26,5)	2,4-20,9	2500	2,4-11,7	5000	4620	3740	3110	2650	2290	2000						
22,5	(r = 24,0)	2,4-21,0	2500	2,4-11,7	5000	4650	3760	3130	2660	2300							
20,0	(r = 21,5)	2,4-20,0	2500	2,4-11,9	5000	4710	3810	3170	2700								

3,9m		3,9m + 5,85m	5,85m	11,7m	63 LC																
10	9+1	7			39,7°	-	-	-	39,9°	-	-	-	40,0°	-	-	-	39,3°	-	-	40,0°	-
9	8+1	6	3		37,7	-	-	-	37,9	-	-	-	38,0	-	-	-	37,3	-	-	38,1	-
8	7+1	5			35,8	-	-	-	36,0	-	-	-	36,1	-	-	-	35,4	-	-	36,2	46,1°
7	6+1	4			33,8	-	45,4°	-	34,0	45,6	45,6°	-	34,1	45,7	45,7°	-	33,4	45,0	45,0°	32,3	44,2
6	5+1	3			31,9	43,5	43,5	-	32,1	43,7	43,7	-	32,2	43,8	43,8	-	31,5	43,1	43,1	30,3	42,2
5	4+1	2			29,9	41,5	41,5	-	30,1	41,7	41,7	-	30,2	41,8	41,8	-	29,5	41,1	41,1	28,4	40,3
4	3+1	1			28,0	39,6	39,6	-	28,2	39,8	39,8	-	28,3	39,9	39,9	-	27,6	39,2	39,2	26,4	38,3
3	2+1				26,0	37,6	37,6	-	26,2	37,8	37,8	-	26,3	37,9	37,9	-	25,6	37,2	37,2	24,5	36,4
2	1+1				24,1	35,7	35,7	-	24,3	35,9	35,9	-	24,4	36,0	36,0	-	23,7	35,3	35,3	22,5	34,4
1	0+1				22,1	33,7	33,7	-	22,3	33,9	33,9	-	22,4	34,0	34,0	-	21,7	33,3	33,3	20,6	32,5
0	0				20,2	31,8	31,8	-	20,4	32,0	32,0	-	20,5	32,1	32,1	-	19,8	31,4	31,4	18,6	30,5
					18,2	29,8	29,8	-	18,4	30,0	30,0	-	18,5	30,1	30,1	-	17,8	29,4	29,4	16,7	28,6
					16,3	27,9	27,9	-	16,5	28,1	28,1	-	16,6	28,2	28,2	-	15,9	27,5	27,5	14,7	26,6
					14,3	25,9	25,9	-	14,5	26,4	26,4	-	14,6	26,5	26,5	-	13,9	25,8	25,8	12,8	24,7
					12,4	24,0	24,0	-	12,6	24,2	24,2	-	12,7	24,3	24,3	-	12,0	23,6	23,6	10,8	22,7
					10,4	22,0	22,0	-	10,6	22,2	22,2	-	10,7	22,3	22,3	-	10,0	21,6	21,6	8,9	20,8
					8,5	20,1	20,1	-	8,7	20,3	20,3	-	8,8	20,4	20,4	-	8,1	19,7	19,7	6,9	18,9
					6,5	18,1	18,1	-	6,8	18,3	18,3	-	6,9	18,4	18,4	-	6,2	17,7	17,7	5,0	16,9
					4,6	16,2	16,2	-	4,8	16,5	16,5	-	4,9	16,6	16,6	-	4,2	15,9	15,9	3,0	14,9
					-	12,3	12,3	-	-	12,5	12,5	-	-	12,6	12,6	-	-	11,9	11,9	-	11,0

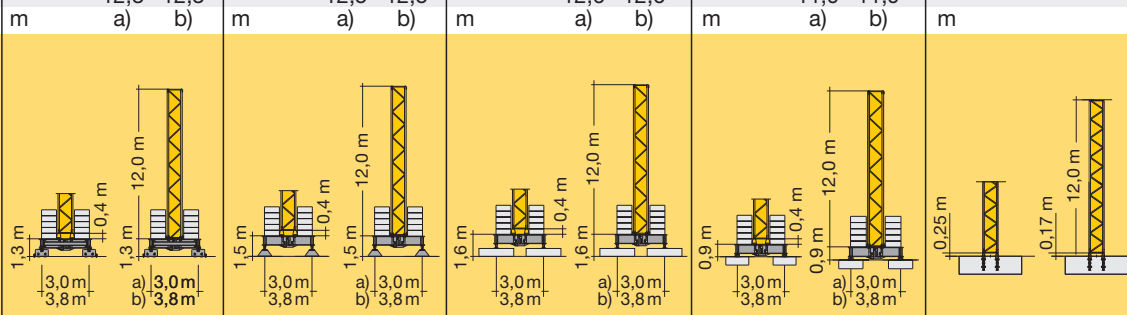

○ = Ohne Kabine / Without cabin / Sans cabine / Senza cabina / Sin cabina / Sem cabine / Без кабины

Weitere Hubhöhen sowie Klettern auf Anfrage. / Further hoist heights and climbing on request. / Hauteurs sous crochet plus élevées et hissage sur demande. / Altre altezze di sollevamento come pure telescopaggio, su richiesta. / Para alturas bajo gancho superiores y trepado, consultar. / Outras alturas de elevação e ascensionamento, mediante consulta. / Другие высоты подъема и наращивание крана – по запросу.









































Antriebe

Driving units / Mécanismes d entraînement / Meccanismi / Mecanismos / Mecanismos / Приводы

	U/min 0 ↔ 0,8 sl./min tr./min	5,0 kW EDC
	0 ↔ 60,0 m/min 0 ↔ 63,0 m/min	1,5 kW FU 3,0 kW FU
	25,0 m/min 25,0 m/min	2 x 3,0 kW FU 2 x 4,0 kW
	kVA	14,0 kW 29,0

	Stufe / Step / Cran Marcia / Marcha Marcha / Передача	kg	m/min
3,2 / 14,0 / 14,0 kW WIW 210 MZ 402			
 57,0 m / 28,0 m LS-Trommel	4 Lagen Layers Couches Avvolgimenti Camadas Capas Слоёв	1 2500 2500 6,2 2 2500 2500 27,0 3 1300 1200 54,0	
		1 5000 3,1 2 5000 13,5 3 2500 27,0	
	 90,0 m / 45,0 m LS-Trommel	6 Lagen Layers Couches Avvolgimenti Camadas Capas Слоёв	1 2400 2300 6,5 2 2400 2300 28,5 3 1200 1100 57,0
		1 4700 3,3 2 4700 14,3 3 2350 28,5	

Montagengewichte: siehe Betriebsanleitung. / Erection weights: see instruction manual. / Poids de montage: voir manuel de service. / Pesi di montaggio: vedere manuale d'uso. / Peso para el montaje: según manual. / Pesos de montagem: veja-se as instruções p. uso. / Масса монтируемых частей: см. инструкцию по эксплуатации.

Kranoberteil		Upper part of crane / Partie supérieure de grue / Parte superiore della gru Parte superior grúa / Parte superior do guindaste / Верхняя часть крана	L (m)	B (m)	H (m)	kg*			
Pos. Item Rep Voce Pos. Ref. Поз.	Anz. Qty. Qte. Qta. Cant. Cant. Кол-во	Drehbühne kpl. / Slewing platform cpl. / Ensemble mât cabine cpl. / Piattaforma girevole compl. / Plataforma giratória compl. / Conjunto plataforma de giro Поворотная платформа в сб.							
1	1		2,43	2,74	2,52	3520			
2	1	Drehbühne / Slewing platform / Ensemble mât-cabine / Piattaforma girevole / Conjunto plataforma de giro / Plataforma giratória Поворотная платформа			2,43	1,99	2,52	3310	
3	1	Podeste / Plates-formes / Plates-formes Pedana / Plataformas / Plataformas Площадки			2,07 2,07 2,13	0,59 1,04 0,60	1,31 1,31 1,33	100 110 120	
4	1	Kabine / Cabin / Cabine Cabina / Cabina / Cabina Кабина			1,35	2,38	2,28	580	
5	1	Gegenausleger / Counter-jib / Contre-flèche Controfreccia / Contrapluma / Contra-lança Консоль противовеса			11,02	1,39	0,66	2190	
6	1	Podeste Gegenausleger / Counter-jib platforms Plates-formes de contre-flèche / Ballatoi controfreccia Plataforma contrapluma / Plataforma contra-lança Площадки консоли противовеса			3,00	0,75	1,32	140	
7	1	Ausleger-Anlenkstück / Jib heel section / Pied de flèche Sezione articolata braccio / Pluma tramo primero / Base articulada de lança / Корневая секция стрелы			10,05	1,23	1,95	① 1820	
8	1	Ausleger-Zwischenstück / Intermediate jib section Élément intermédiaire de flèche / Sezione intermedia braccio / Tramo intermedio pluma / Peça suplementar da lança / Промежуточная секция стрелы			2,69 7,68 5,17 5,17	1,10 1,10 1,10 1,10	1,25 1,24 1,23 1,23	④ 160 ⑤ 380 ⑥ 200 ⑦ 170	
9	1	Ausleger-Zwischenstück / Intermediate jib section Élément intermédiaire de flèche / Sezione intermedia braccio / Tramo intermedio pluma / Peça suplementar da lança / Промежуточная секция стрелы			10,20	1,10	1,83	③ 740	
10	1	Ausleger-Kopfstück / Jib head section / Pointe de flèche Punta braccio / Tramo punta de pluma / Cabeça de lança Концевая секция стрелы			1,24	1,11	0,44	⑧ 60	
11	1	Laufkatze / Trolley / Chariot Carrello / Carrito / Carrinho Грузовая тележка			1,60	1,28	0,78	163	
12	1	Fahrkorb / Maintenance cage / Nacelle d'entretien Cestello di manutenzione / Plataforma de mantenimiento Передвижная платформа			0,78	0,66	1,25	35	
Turm		Tower / Mât / Torre Torre / Torre / Башня							
13	1	Grundturmstück / Base tower section / Mât de base Elemento di torre base / Tramo torre base Peça de base de torre / Секция основания			12,00	1,42	1,42	3320	
14	1	Turmstück / Tower section Élément de mât / Elemento di torre Tramo torre / Torre / Башенная секция			3,90 m 5,85 m 11,70 m	4,17 6,12 11,97	1,20 1,20 1,20	970 1330 2450	
Klettereinrichtung		Climbing equipment / Equipement de télescopage / Attrezzatura per allungamento della gru Equipo de trepado / Acsórios p. subida no edificio / Обойма наращивания							
15	1	Führungsstück kpl. / Guide section cpl. / Cage télescopique cpl. / Gabbia de sopraelevazione compl. / Torre de montaje completa / Peça de guia compl. / Направляющая секция в сб.			8,74	1,66	1,75	2680	
16	1	Führungsstück Turmstück / Tower guide section / Élément de mât télescopique / Gabbia de sopraelevazione / Tramo torre de montaje / Peça de guia / Направляющая секция			3,90 m	4,17	1,66	1,66	1190
17	1	Hydraulanlage, Stütz- und Klettertraverse / Hydraulic unit, supporting and climbing cross members / Système hydraul. avec traverses d'appui et de télescop. Sist. idraul., traversa di appoggio e allugam. gru / Sistema hidráulico con traviesa de apoio y trepado / Instalação hidráulica, travessa de apoio e subida / Гидроагрегат, стойка-упор и траверса обоймы наращивания			2,00	0,90	0,80	530	
Fundamentkreuz		Cruciform base / Châssis en croix / Crociera Carro de guindaste / Base cruciforme / Фундаментная крестовина							
18	1	Tragholm I / Arm I / Longeron I Longherone I / Travessa I Brazo I / Несущая балка I			3,0 m 3,8 m	4,88 5,68	0,71 0,71	0,81 0,81	1550 1790
19	1	Tragholm II / Arm II / Longeron II Longherone II / Travessa II Brazo II / Несущая балка II			3,0 m 3,8 m	4,88 5,68	0,78 0,78	0,66 0,66	1340 1580
20	2	Fahrschemel mit Antrieb / Rail bogie with drive / Bogie moteur / Telajo con grappa propulsore / Caja rodillo motriz Quadra sem grpa de propulsão / Подрамник с приводом			1,31 0,96	0,66 0,38	0,61 0,42	630 280	
21	2	Fahrschemel ohne Antrieb / Rail bogie without drive / Bogie fou / Telajo senza grappa propulsore / Caja rodillo conducido Quadra com grpa de propulsão / Подрамник без привода			1,04 0,38	0,33 0,31	0,61 0,42	330 200	

* Einzelgewichte. / Single weights. / Poids individuels. / Singoli pesi. / Pesos unitarios. / Pesos de peças componentes. / Индивидуальный вес.

Konstruktionsänderungen vorbehalten! / Subject to alterations! / Sous réserves de modifications! / Riservato il diritto di modifiche strutturali!
¡Sujeto a modificaciones! / Salvo modificação da construação! / Права на внесение конструкторских изменений сохраняются!

Sämtliche Angaben erfolgen ohne Gewähr. / This information is supplied without liability. / Ces renseignements sont sans garantie. / Tutte le indicazioni fornite senza garanzia. / Declinamos toda responsabilidad derivada de la información proporcionada. / Declinamos qualquer responsabilidade quanto à informação fornecida. / Все данные указаны без обязательств.

120 P – 5839 • EN 14439:2009 – DIN 15018-H1/B3 • BGL C.0.10.0045 • 04.10 / 7

Printed in Germany.

Liebherr-Werk Biberach GmbH
Postfach 1663, D-88396 Biberach an der Riss
☎ +49 73 51 41-0, Fax: +49 73 51 41 22 25
www.liebherr.com, E-Mail: info.lbc@liebherr.com

Liebherr Industrias Metálicas, S.A.
Polígono Industrial Agustinos, Apartado 4096, E-31014 Pamplona
☎ +34-948-29 70 00, Fax +34-948-29 70 29
www.liebherr.com, E-Mail: info.lim@liebherr.com