

FLAT TOP TOWER CRANE

**Specifications:**

- ▶ Max jib length: 65,00 m
- ▶ Capacity at max length: 2,00 t
- ▶ Max capacity: 10,00 t

WORKS FOR YOU.™

KEY

Zeichenerklärung · Légende · Leyenda · Legenda · legenda · условные обозначения



Hoisting · Heben · Levage · Elevación · Sollevamento · Elevação · подъем



Trolleying · Katzfahren · Distribution · Distribución · Traslazione carrello · Distribuição · перемещение



Slewing · Schwenken · Orientation · Orientació · Rotazione · giro · поворот



Travelling · Schienenfahren · Translation · Traslación · Traslazione · Móvel · Движение



Directive on noise level · Richtlinie für den Schall-Leistungspegel · Directive sur le niveau acoustique · Directiva sobre el nivel acústico · Direttiva sul livello acustico · Directiva sobre nivel de ruidos · Директива по уровню шума



Consult us · Auf Anfrage · Nous consulter · Consultarnos · Consultateci · Consulte-nos · Проконсультироваться с нами



Power requirements · Geforderte Stromstärke · Puissance totale nécessaire · Potencia necesaria · Potenza totale richiesta · Requisitos de energia · Требования по питанию



Power supply · Stromversorgung · Alimentation · Alimentación · Alimentazione · Fonte de alimentação · Питание



In service · In Betrieb · En service · En servicio · In servizio · Em serviço · При работе



Out of service · Außer Betrieb · Hors service · Fuera de servicio · Fuori servizio · Fora de serviço · В режиме простоя



Max. under hook height · Höchste Hakenhöhe · Hauteur maxi. sous crochet · Maxima altura bajo gancho · Altezza max. sotto gancio · alt. máx. sob o gancho · макс высота до крюка



Without load, without ballast, max. jib and max. height · Ohne Last und Ballast, mit Maximalausleger und Maximalhöhe · A vide, sans lest, avec flèche et hauteur maximum · Sin carga, sin lastre, con pluma y altura máxima · A vuoto, senza zavorra, braccio max., altezza max. · Sem carga, sem lastro, lança máxima, altura máxima · Без груза, без балласта, на макс. Длине вспомогательной стрелы и макс. Высоте



Counterweight · Gegengewicht · Lest de contre-flèche · Lastre de contra flecha · Zavorra controbraccio · Contrapeso · Противовес

C25

FEM 1004 Out of service wind condition · FEM 1004 Windverhältnisse im Außerbetriebszustand · FEM 1004 Conditions de vent hors service · FEM 1004 Condiciones de viento fuera de servicio · FEM 1004 Condizioni del vento in fuori servizio · FEM 1004 Condição do vento para fora de serviço · FEM 1004 Сила ветра, при которой работа запрещена

CONTENTS

CTT 191-10 TS21

Inhalt · Contenu · Contenido · Indice · Sumário · содержание

Page · Seite · Page · Página · Pagina · Página · Страница:

Load Diagram · Lastkurven · Courbes de charges · Curvas de cargas · Diagramma di portata · diagrama de carga · схема нагрузок	4
Tower · Turm · Tour · Torre · Torre · Torre · Башня	6
Other configurations · Aufstellmöglichkeiten · Autres Implantations · Otras Implantaciones · Altre Installazioni · Outras configurações · Другие конфигурации	8
Mechanism · Antriebe · Mécanismes · Mecanismos · Meccanismi · mecanismo · механизм	9
Transportation · Transport · Transportation · Transportation · Trasporto · transporte · транспортировка	10

LOAD DIAGRAM

Lastkurven · Courbes de charges · Curvas de cargas · Diagramma di portata · Diagrama de carga · Схема нагрузок

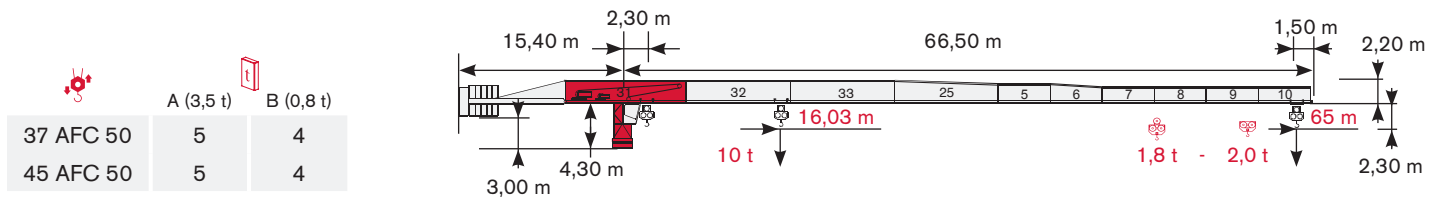

			10 m	15 m	20 m	25 m	30 m	35 m	40 m	45 m	50 m	55 m	60 m	65 m	
	5 t →	30,30 m	t	5,00	5,00	5,00	5,00	5,00	4,24	3,63	3,15	2,78	2,47	2,22	2,00
	5 t →	29,27 m	t	5,00	5,00	5,00	5,00	4,86	4,04	3,43	2,95	2,58	2,27	2,02	1,80
	10 t →	16,03 m	t	10,00	10,00	7,78	6,01	4,86	4,04	3,43	2,95	2,58	2,27	2,02	1,80

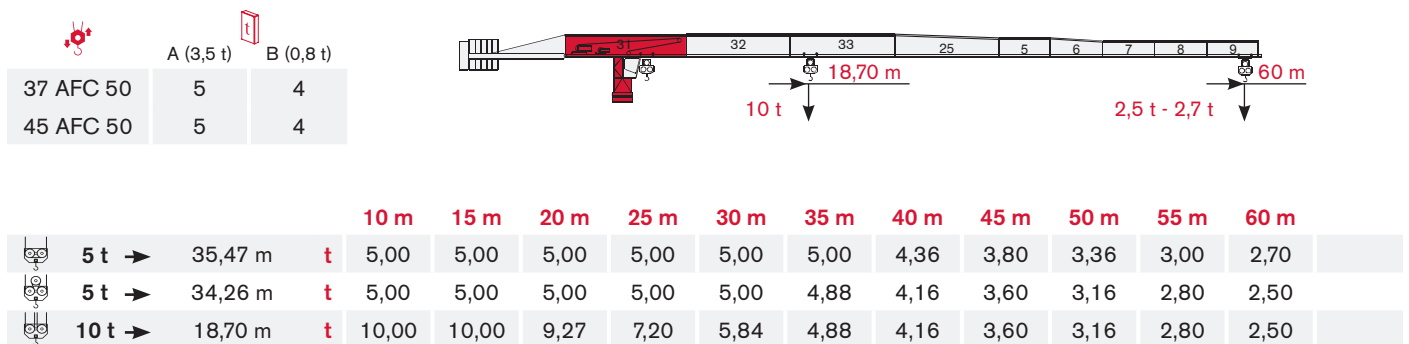

			10 m	15 m	20 m	25 m	30 m	35 m	40 m	45 m	50 m	55 m	60 m	
	5 t →	35,47 m	t	5,00	5,00	5,00	5,00	5,00	4,36	3,80	3,36	3,00	2,70	
	5 t →	34,26 m	t	5,00	5,00	5,00	5,00	5,00	4,88	4,16	3,60	3,16	2,80	2,50
	10 t →	18,70 m	t	10,00	10,00	9,27	7,20	5,84	4,88	4,16	3,60	3,16	2,80	2,50

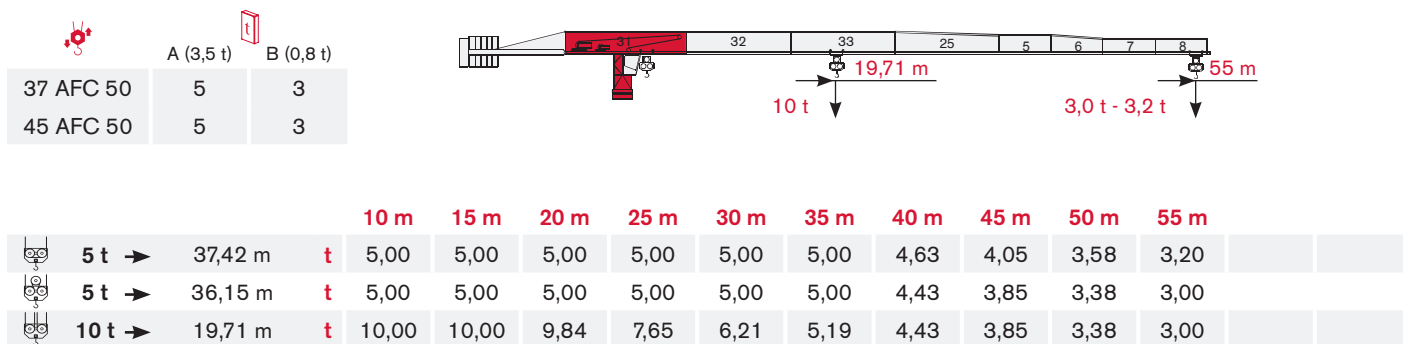

			10 m	15 m	20 m	25 m	30 m	35 m	40 m	45 m	50 m	55 m	
	5 t →	37,42 m	t	5,00	5,00	5,00	5,00	5,00	4,63	4,05	3,58	3,20	
	5 t →	36,15 m	t	5,00	5,00	5,00	5,00	5,00	4,43	3,85	3,38	3,00	
	10 t →	19,71 m	t	10,00	10,00	9,84	7,65	6,21	5,19	4,43	3,85	3,38	3,00

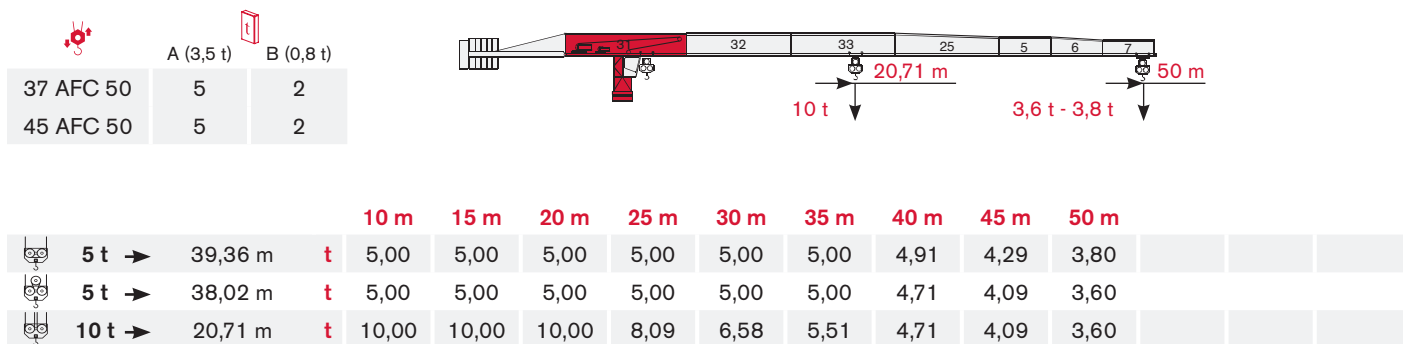

			10 m	15 m	20 m	25 m	30 m	35 m	40 m	45 m	50 m	
	5 t →	39,36 m	t	5,00	5,00	5,00	5,00	5,00	4,91	4,29	3,80	
	5 t →	38,02 m	t	5,00	5,00	5,00	5,00	5,00	4,71	4,09	3,60	
	10 t →	20,71 m	t	10,00	10,00	10,00	8,09	6,58	5,51	4,71	4,09	3,60

CTT 191-10 TS21

		A (3,5 t)	B (0,8 t)
37 AFC 50		5	-
45 AFC 50		5	-

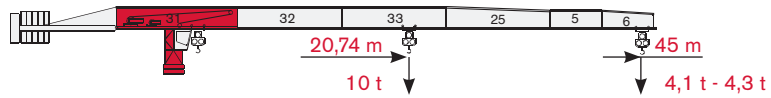

			10 m	15 m	20 m	25 m	30 m	35 m	40 m	45 m				
	5 t →	39,43 m	t	5,00	5,00	5,00	5,00	5,00	5,00	4,92	4,30			
	5 t →	38,08 m	t	5,00	5,00	5,00	5,00	5,00	5,00	4,72	4,10			
	10 t →	20,74 m	t	10,00	10,00	10,00	8,11	6,59	5,52	4,72	4,10			

		A (3,5 t)	B (0,8 t)
37 AFC 50		4	3
45 AFC 50		4	3

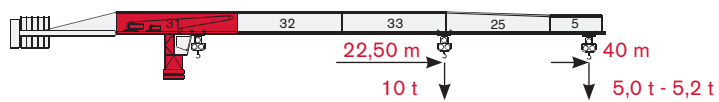

				10 m	15 m	20 m	25 m	30 m	35 m	40 m				
	5 t →	40,00 m	t	5,00	5,00	5,00	5,00	5,00	5,00	5,00				
	5 t →	40,00 m	t	5,00	5,00	5,00	5,00	5,00	5,00	5,00				
	10 t →	22,50 m	t	10,00	10,00	10,00	8,89	7,24	6,07	5,20				

		A (3,5 t)	B (0,8 t)
37 AFC 50		4	1
45 AFC 50		4	1

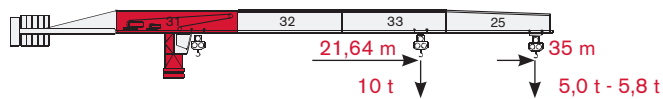

				10 m	15 m	20 m	25 m	30 m	35 m					
	5 t →	35,00 m	t	5,00	5,00	5,00	5,00	5,00	5,00					
	5 t →	35,00 m	t	5,00	5,00	5,00	5,00	5,00	5,00					
	10 t →	21,64 m	t	10,00	10,00	10,00	8,51	6,92	5,80					

		A (3,5 t)	B (0,8 t)
37 AFC 50		3	3
45 AFC 50		3	3

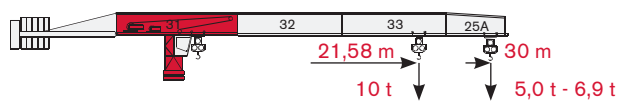

				10 m	15 m	20 m	25 m	30 m						
	5 t →	30,00 m	t	5,00	5,00	5,00	5,00	5,00						
	5 t →	30,00 m	t	5,00	5,00	5,00	5,00	5,00						
	10 t →	21,58 m	t	10,00	10,00	10,00	8,48	6,90						

TOWER

Turn · Tour · Torre · Torre · Torre · Башня

Standard Configurations · Standardkonfiguration · Standard Implantations ·
 Implantaciones Standard · Installazioni Standard · Configuração padrão ·
 стандартная конфигурация крана

Tower: TS21 & Basement: R3

	●	◆	◆ C25
R1	-1746 kN	-2241 kN	-1993 kN
R2	1309 kN	1871 kN	1694 kN
	530 kN		

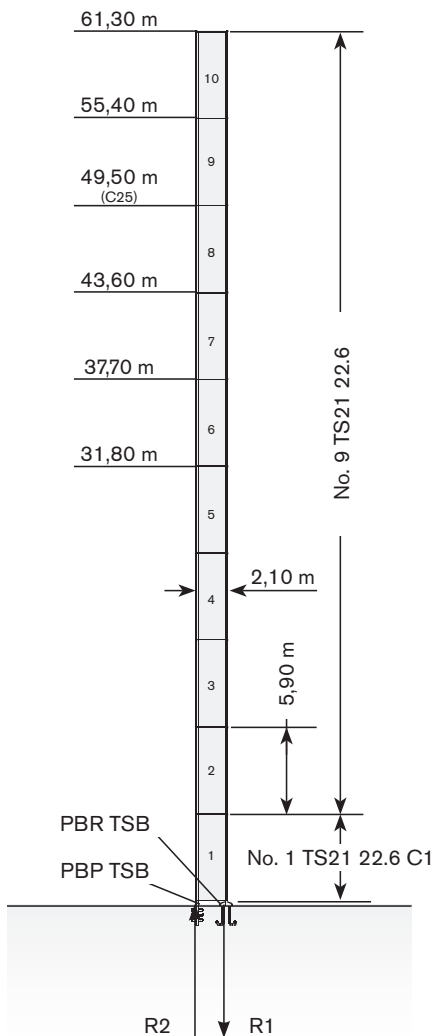

Tower: TS21 & Basement: FP3

	●	◆	◆ C25
R1	-951 kN	-1115 kN	-1198 kN
R2	0 kN	0 kN	0 kN
	624 kN		

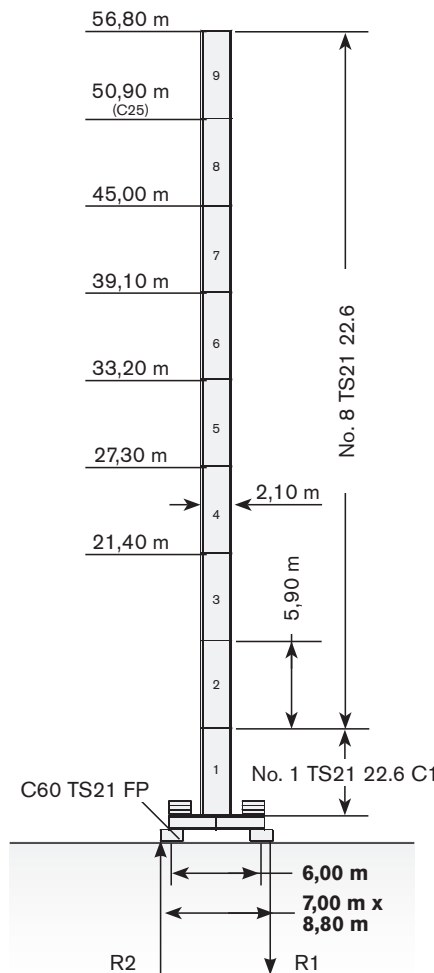

Tower: TS21 & Basement: T3

	●	◆	◆ C25
R1	-849 kN	-718 kN	-1040 kN
R2	0 kN	0 kN	0 kN
	671 kN		

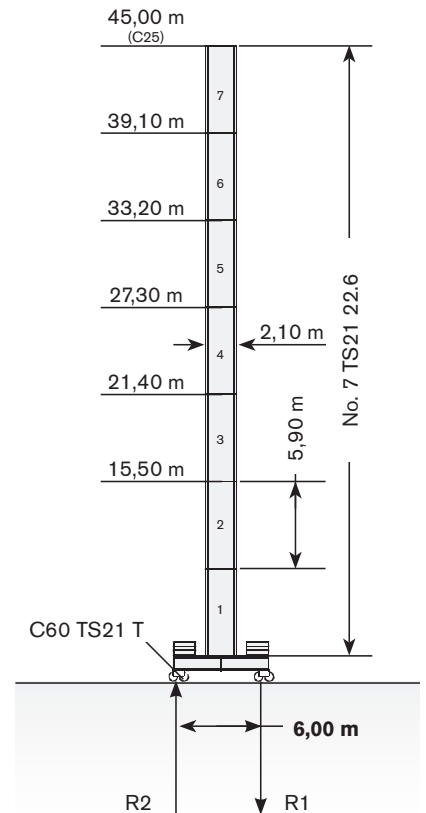

Max. under hook height · Höchst Hakenhöhe · Hauteur maxi. sous crochet · Maxima altura bajo gancho · Altezza max. sotto gancio · alt. máx. sob o gancho · макс высота до крюка

The available lengths for the TS tower sections are 11.8 m, 5.9 m, 2.95 m. • Die Turmschüsse TS sind mit Längen 11.8 m, 5.9 m, 2.95 m verfügbar. • Les éléments de mât TS sont disponibles en longueur 11.8 m, 5.9 m, 2.95 m. • Los tramos de torre TS son disponibles en las medidas de largo 11.8 m, 5.9 m, 2.95 m. • Le prolunghe TS sono disponibili in lunghezze 11.8 m, 5.9 m, 2.95 m. • Os comprimentos disponíveis para elementos de torre TS são: 11.8m, 5.9m e 2.95m. • Длина поставляемых секций башни TS - 11.8 м, 5.9 м, 2.95 м.

Other configurations · Aufstellmöglichkeiten · Autres Implantations · Otras Implantaciones · Altre Installazioni · Outras configurações · Другие конфигурации

Bottom climbing crane · Kletterkran im Gebäude · Télescopage sur dalles · Telescopage grúa trepadora · Gru climbing · Guindaste automontante interno · Самоподъемный кран

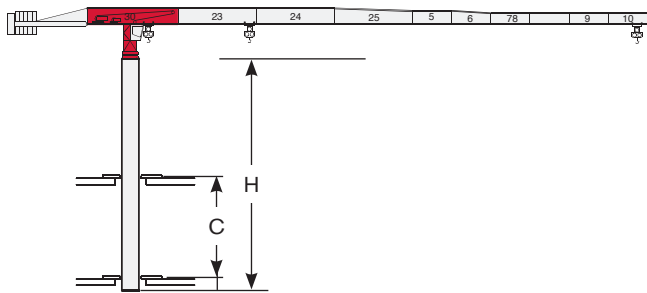

	min	max
C		
H		i

Crane tied to the structure · Geankerter Kran · Grue ancrée · Grúa anclada · Gru ancorata · Guindaste ancorado na estrutura · Кран, крепящийся к сооружению

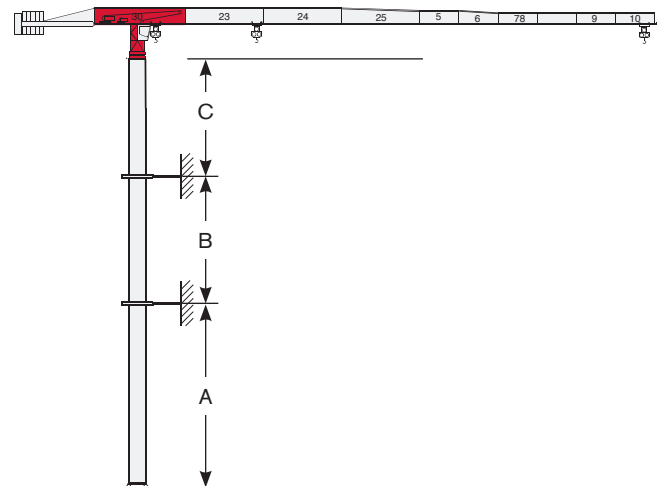

	min	max
A		
B		i
C		







Consult us · Auf Anfrage · Nous consulter · Consultarnos · Consultateci · Consulte-nos · Проконсультироваться с нами

MECHANISMS





Antriebe · Mécanismes · Mecanismos · Meccanismi · Mecanismo · Механизм





Power supply · Stromversorgung · Alimentation · Suministro eléctrico · Alimentazione · Requisitos de energia · Требования по питанию

				
	37 AFC 50 D2	81 kVA*	400V - 50Hz / 460V - 60Hz	2000/14/CE modificata
	45 AFC 50	93 kVA*	400V - 50Hz / 460V - 60Hz	2000/14/CE modificata

* Crane without travelling equipment – Three movements simultaneous at 90% · Krane ohne Schienenfahren – Drei gleichzeitige Bewegungen mit 90% · Grue sans translation – Trois mouvements simultanés à 90% · Grúa sin traslación – Tres movimientos contemporáneos hechos al 90% · Gru senza traslazione – Tre movimenti contemporanei al 90% · Guindaste sem equipamento de translação – três movimentos simultâneos a 90% · Кран без транспортируемого оборудования – движение груза в трех плоскостях возможно при 90% нагрузки

Hoisting · Heben · Levage · Elevación · Sollevamento · Elevação · Подъем





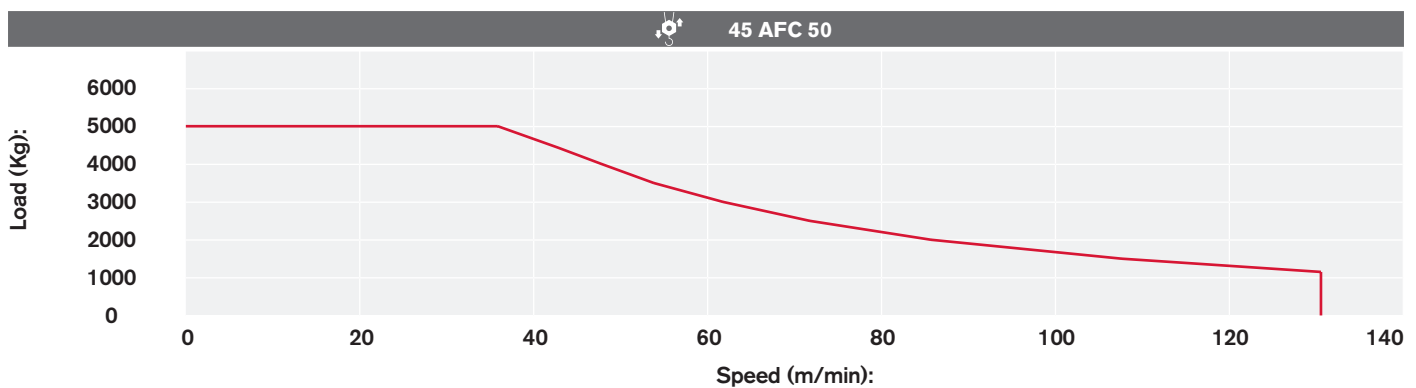
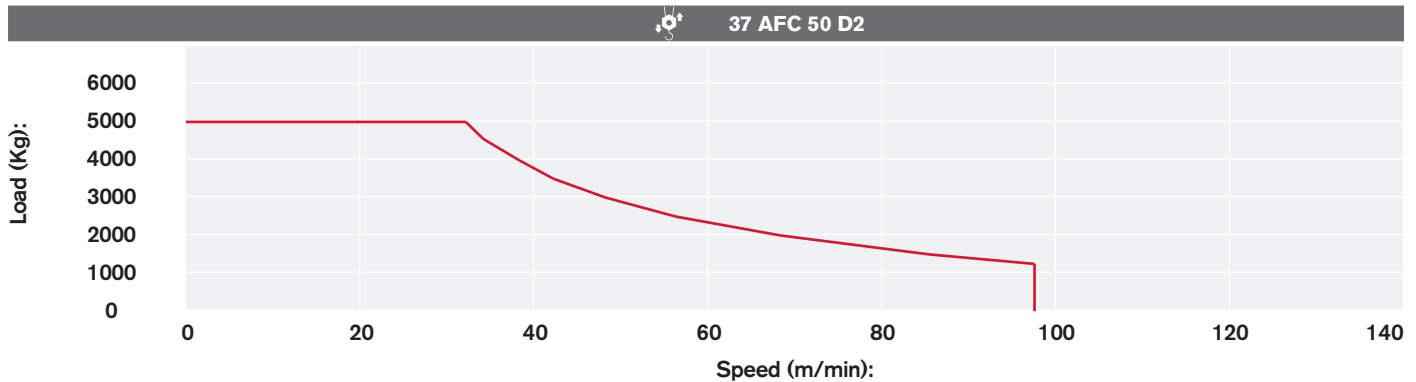

			t	m/min	kW	
	37 AFC 50 D2		5	0 → 2	37	530 m
			5	2 → 8		
			5	8 → 33		
			2,2	33 → 66		
			1,2	66 → 96		
			10	0 → 1		
			10	1 → 4		
			10	4 → 16		
			4,4	16 → 33		
			2,4	33 → 48		

			t	m/min	kW	
	45 AFC 50		5	0 → 2	45	670 m
			5	2 → 8		
			5	8 → 36,5		
			2,2	36,5 → 80		
			1,15	80 → 131		
			10	0 → 1		
			10	1 → 4		
			10	4 → 18,2		
			4,4	18,2 → 40		
			2,25	40 → 65,5		

Hoisting Speed · Heben Geschwindigkeit · Vitesse de Levage · Velocidad de Elevación · Velocità' di Sollevamento · Velocidade de içamento · Скорость подъема









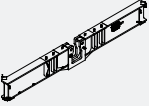
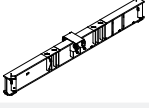
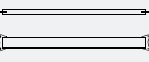
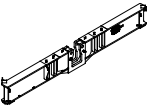
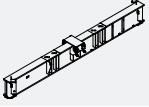
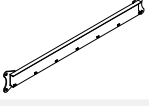

Additional Specifications · Weitere Leistungsdaten · Spécifications additionnelles · Otras prestaciones · Altre movimentazioni · Especificações adicionais · Дополнительные спецификации

	DVF 3 6 D1	0 → 40 → 80 m/min	5.5 kW
	SSR 2 2 65	0,7 r.p.m. (50Hz) / 0,84 r.p.m. (60Hz)	2 x 65 Nm
	TAD 2RP 2M4	0 → 24 m/min	2 x 4 kW
	TAD 2RG 4M3	0 → 24 m/min	4 x 3 kW
	TAD 2RG 4M4	0 → 24 m/min	4 x 4 kW
			

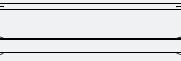
TRANSPORTATION

Transport · Transport · Conducción · Trasporto · Transporte · Транспортировка

Packing list

CTT 191-10/TS21	DESCRIPTION · BESCHREIBUNG · DESCRIPTION · DESCRIPCIÓN · DESCRIZIONE · DESCRIÇÃO · ОПИСАНИЕ	LENGTH · LÄNGE · LONGUEUR · LONGITUD · LUNGHEZZA · COMPRIMENTO · ДЛИНА	WIDTH · BREITE · LARGEUR · ANCHURA · LARGHEZZA · LARGURA · ШИРИНА	HEIGHT · HÖHE · HAUTEUR · ALTURA · ALTEZZA · ALTURA · ВЫСОТА	QUANTITY · MENGE · QUANTITÉ · CANTIDAD · CANTITÀ · QUANTIDADE · КОЛИЧЕСТВО	WEIGHT · GEWICHT · POIDS · PESO · PESO · ВЕС
	BEAM "A" FOR UNDERCARRIAGE C45	6,80 m	0,40 m	1,10 m	1	2700 kg
	BEAM "B" FOR UNDERCARRIAGE C45	6,80 m	0,70 m	0,90 m	1	2700 kg
	CROSSBEAMS UNDERCARRIAGE C45	4,40 m	0,12 m	0,54 m	2	230 kg
	"A" BEAM FOR UNDERCARRIAGE C45	6,80 m	0,40 m	1,00 m	1	2820 kg
	"B" BEAM FOR UNDERCARRIAGE C45	6,80 m	0,75 m	0,80 m	1	2620 kg
	CROSSBEAM FOR UNDERCARRIAGE C45	4,40 m	0,12 m	0,54 m	2	230 kg
	BEAM "A" UNDERCARRIAGE C60	8,90 m	0,40 m	1,10 m	1	3600 kg
	BEAM "B" UNDERCARRIAGE C60	8,90 m	0,70 m	0,90 m	1	3600 kg
	SLEEPERS UNDERCARRIAGE C60	5,90 m	0,60 m	0,20 m	2	450 kg
	TS21 22.3 TOWER SECTION	2,10 m	2,10 m	2,98 m	1	1382 kg*
	TS21 22.3 C2 TOWER SECTION	2,10 m	2,10 m	2,98 m	1	1440 kg*
	TS21 22.6 TOWER SECTION	2,10 m	2,10 m	5,93 m	1	2550 kg*
	TS21 22.6 C1 TOWER SECTION	2,10 m	2,10 m	5,93 m	1	2800 kg*
	TS21 22.6 C2 TOWER SECTION	2,10 m	2,10 m	5,93 m	1	2611 kg*

CTT 191-10 TS21

CTT 191-10/TS21	DESCRIPTION · BESCHREIBUNG · DESCRIPTION · DESCRIPCIÓN · DESCRIZIONE · DESCRIÇÃO · ОПИСАНИЕ	LENGTH · LÄNGE · LONGUEUR · LONGITUD · LUNGHEZZA · COMPRIMENTO · ДЛИНА	WIDTH · BREITE · LARGEUR · ANCHURA · LARGHEZZA · LARGURA · ШИРИНА	HEIGHT · HÖHE · HAUTEUR · ALTURA · ALTEZZA · ALTURA · ВЫСОТА	QUANTITY · MENGE · QUANTITÉ · CANTIDAD · QUANTITÀ · QUANTIDADE · КОЛИЧЕСТВО	WEIGHT · GEWICHT · POIDS · PESO · PESO · ВЕС
	SLEWING UNIT H20	2,30 m	2,30 m	2,30 m	1	5800 kg
	SLEWING UNIT TS21	2,50 m	2,20 m	1,80 m	1	5150 kg
	CAB	3,50 m	1,70 m	2,50 m	1	1230 kg
	COUNTERJIB COMPLETE	9,60 m	1,60 m	0,80 m	1	2620 kg
	JIB POINT SECTION	1,20 m	0,80 m	1,00 m	1	62 kg
	JIB TROLLEY	1,40 m	1,40 m	1,00 m	1	249 kg
	HOIST WINCH	3,40 m	2,40 m	2,20 m	1	2300 kg
	BALLAST BASKET	2,70 m	1,20 m	0,80 m	1	265 kg
	CAB SECTION	3,50 m	1,90 m	1,30 m	1	1983 kg
	HOIST BLOCK	1,40 m	0,90 m	0,40 m	1	411 kg
	JIB SECTION 31	11,90 m	1,20 m	2,30 m	1	4640 kg
	JIB SECTION 32	10,30 m	1,10 m	2,20 m	1	2413 kg
	JIB SECTION 33	10,30 m	1,10 m	2,20 m	1	1632 kg
	JIB SECTION 5	5,20 m	1,10 m	1,80 m	1	532 kg
	JIB SECTION 6	5,00 m	1,10 m	1,80 m	1	508 kg
	JIB SECTION 7	5,00 m	1,10 m	1,30 m	1	453 kg

* Inclusive of ladder, ladder support and protection, platform

TRANSPORTATION

Transport · Transport · Conducción · Trasporto · Transporte · Транспортировка

CTT 191-10/TS21	DESCRIPTION · BESCHREIBUNG · DESCRIPTION · DESCRIPCIÓN · DESCRIZIONE · DESCRIÇÃO · ОПИСАНИЕ	LENGTH · LÄNGE · LONGUEUR · LONGITUD · LUNGHEZZA · COMPRIMENTO · ДЛИНА	WIDTH · BREITE · LARGEUR · ANCHURA · LARGHEZZA · LARGURA · ШИРИНА	HEIGHT · HÖHE · HAUTEUR · ALTURA · ALTEZZA · ALTURA · ВЫСОТА	QUANTITY · MENGE · QUANTITÉ · CANTIDAD · QUANTITÀ · QUANTIDADE · КОЛИЧЕСТВО	WEIGHT · GEWICHT · POIDS · PESO · PESO · ВЕС
	JIB SECTION 8	5,00 m	1,10 m	1,30 m	1	405 kg
	JIB SECTION 9	5,00 m	1,10 m	1,30 m	1	309 kg
	JIB SECTION 10	5,00 m	1,10 m	1,30 m	1	283 kg

NOTES

CTT 191-10 TS21

Notizen · Note · Apunte · Appunti · Notas · ноты

Effective Date: July 2013.

Product specifications and prices are subject to change without notice or obligation. The photographs and/or drawings in this document are for illustrative purposes only. Refer to the appropriate Operator's Manual for instructions on the proper use of this equipment. Failure to follow the appropriate Operator's Manual when using our equipment or to otherwise act irresponsibly may result in serious injury or death. The only warranty applicable to our equipment is the standard written warranty applicable to the particular product and sale and Terex makes no other warranty, express or implied. Products and services listed may be trademarks, service marks or trade-names of Terex Corporation and/or its subsidiaries in the USA and other countries. All rights are reserved. Terex® is a registered trademark of Terex Corporation in the USA and many other countries.

Gültig ab: Juli 2013.

Produktbeschreibungen und Preise können jederzeit und ohne Verpflichtung zur Ankündigung geändert werden. Die in diesem Dokument enthaltenen Fotos und/oder Zeichnungen dienen rein anschaulichen Zwecken. Anweisungen zur ordnungsgemäßen Verwendung dieser Ausrüstung entnehmen Sie bitte dem zugehörigen Betriebshandbuch. Nichtbefolgung des Betriebshandbuchs bei der Verwendung unserer Produkte oder anderweitig fahrlässiges Verhalten kann zu schwerwiegenden Verletzungen oder Tod führen. Für dieses Produkt wird ausschließlich die entsprechende, schriftlich niedergelegte Standardgarantie gewährt. Terex leistet keinerlei darüber hinaus gehende Garantie, weder ausdrücklich noch stillschweigend. Die Bezeichnungen der aufgeführten Produkte und Leistungen sind gegebenenfalls Marken, Servicemarken oder Handelsnamen der Terex Corporation und/oder ihrer Tochtergesellschaften in den USA und anderen Ländern. Alle Rechte vorbehalten. „TEREX“ ist eine eingetragene Marke der Terex Corporation in den USA und vielen anderen Ländern.

Date d'effet : Juillet 2013.

Les spécifications et prix des produits sont sujets à modification sans avis ou obligation. Les photographies et/ou dessins contenus dans ce document sont uniquement pour illustration. Veuillez vous référer à la notice d'utilisation appropriée pour les instructions quant à l'utilisation correcte de cet équipement. Tout manquement au suivi de la notice d'utilisation appropriée lors de l'utilisation de notre équipement ou tout acte autrement irresponsable peut résulter en blessure corporelle sérieuse ou mortelle. La seule garantie applicable à notre équipement est la garantie standard écrite applicable à un produit et à une vente spécifique. Terex n'offre aucune autre garantie, expresse ou explicite. Les produits et services proposés peuvent être des marques de fabrique, des marques de service ou des appellations commerciales de Terex Corporation et/ou ses filiales aux Etats Unis et dans les autres pays, et tous les droits sont réservés. «TEREX» est une marque déposée de Terex Corporation aux Etats Unis et dans de nombreux autres pays.

Fecha efectiva: julio 2013.

Los precios y las especificaciones de productos pueden sufrir cambios sin aviso previo u obligación. Las fotografías o dibujos de este documento tienen un fin meramente ilustrativo. Consulte el manual de instrucciones del operador correspondiente para más información sobre el uso correcto de este equipo. El hecho de no respetar el manual del operador correspondiente al utilizar el equipo o actuar de forma irresponsable puede suponer lesiones graves o fatales. La única garantía aplicable a nuestro equipo es la garantía escrita estándar correspondiente a cada producto y venta, y TEREX no amplía dicha garantía de forma expresa o implícita. Los productos y servicios mencionados pueden ser marcas registradas, marcas de servicio o nombres de marca de TEREX Corporation o de sus filiales en Estados Unidos de América y otros países, y se reservan todos los derechos. „TEREX“ es una marca comercial registrada de Terex Corporation en Estados Unidos de América y muchos otros países.

Data di inizio validità: luglio 2013.

Ci riserviamo il diritto di modificare le specifiche e i prezzi dei prodotti in ogni momento e senza preavviso. Le fotografie e/o i disegni contenuti in questo documento sono destinati unicamente a scopi illustrativi. Consultare le istruzioni sull'uso corretto di questo macchinario, contenute nell'opportuno Manuale dell'operatore. L'inottemperanza delle istruzioni contenute nel Manuale dell'operatore del macchinario e altri comportamenti irresponsabili possono provocare gravi lesioni, anche mortali. L'unica garanzia applicabile ai nostri macchinari è la garanzia scritta standard applicabile al particolare prodotto e alla particolare vendita; Terex è esonerata dal fornire qualsiasi altra garanzia, esplicita o implicita. I prodotti e servizi elencati possono essere dei marchi di fabbrica, marchi di servizio o nomi commerciali di TEREX Corporation e/o società affiliate negli Stati Uniti d'America e altre nazioni e tutti i diritti sono riservati. „TEREX“ è un marchio registrato di Terex Corporation negli USA e molti altri Paesi.

Data de vigência: julho 2013.

Especificações e preços dos produtos sujeitos a alteração sem aviso prévio ou obrigações. As fotografias e/ou desenhos deste documento servem apenas para fins ilustrativos. Consulte o respectivo Manual de Instruções para instruções sobre o uso correto deste equipamento. A falta de atenção ao respectivo Manual do Operador no uso de nosso equipamento ou a operação da máquina em condições impróprias pode resultar em lesão grave ou morte. A única garantia aplicável aos nossos equipamentos é a garantia padrão por escrito, aplicável ao produto específico e à sua venda, sem que nenhuma outra, expressa ou implícita, seja oferecida pela Terex. Os produtos e serviços listados podem ser marcas comerciais, marcas de serviço ou nomes-fantasia da Terex Corporation e/ou suas subsidiárias nos EUA e em outros países. Todos os direitos reservados. Terex® é marca registrada da Terex Corporation nos EUA e muitos outros países.

Вступает в силу: июль 2013 г.

Технические характеристики и цены могут изменяться без предварительного уведомления и без каких-либо обязательств для производителя. Фотографии и (или) чертежи, использованные в документе, приведены исключительно в качестве иллюстраций. Инструкции по правилам эксплуатации даются в соответствующих руководствах для операторов данного оборудования. Невыполнение рекомендаций руководства по эксплуатации нашего оборудования или другие безответственные действия могут повлечь серьезные травмы или смерть. Единственной гарантией, действующей в отношении нашего оборудования, является стандартная форма письменной гарантии на данный тип оборудования и на условия его продажи.



Copyright 2013 Terex Corporation

Terex Cranes, Global Marketing, Dinglerstraße 24, 66482 Zweibrücken, Germany
Tel. +49 (0) 6332 830, Email: info.cranes@terex.com, www.terexcranes.com

Brochure Reference: TC-DS-M-E/F/G//S/P/R-CTT191-10 TS21-07/13

www.terexcranes.com



WORKS FOR YOU.™